



NeRF-DS: Neural Radiance Fields for Dynamic Specular Objects

Zhiwen Yan Chen Li Gim Hee Lee

Department of Computer Science, National University of Singapore

Project Page





Existing Dynamic NeRF

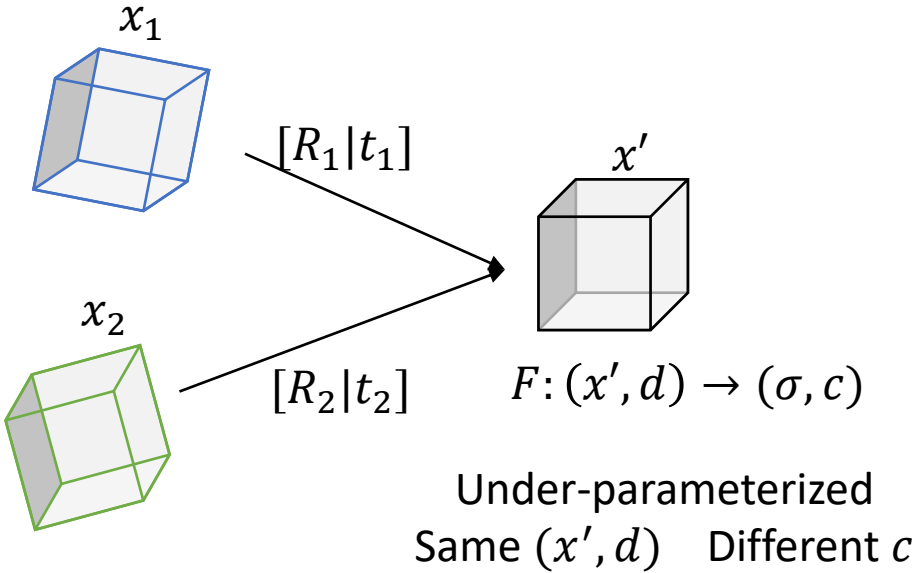
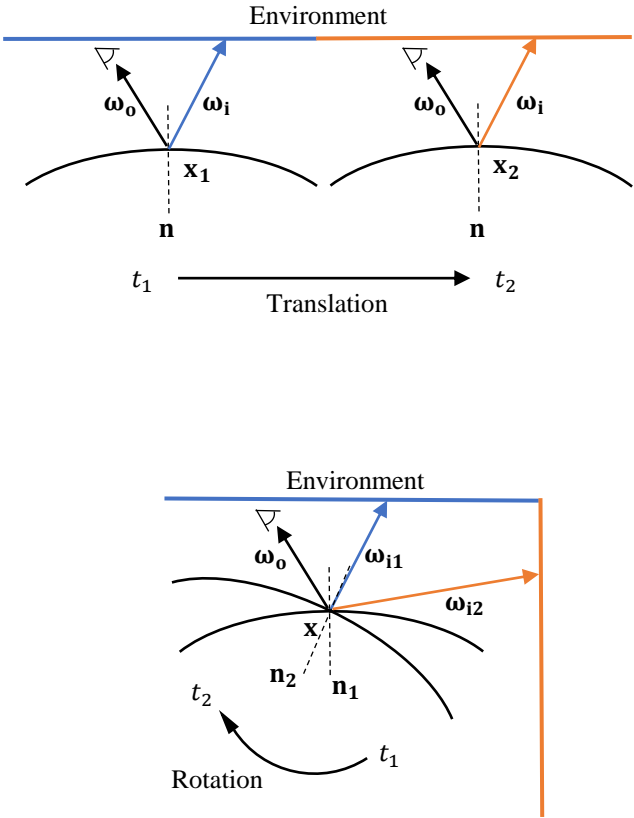

Surface Aware Dynamic NeRF

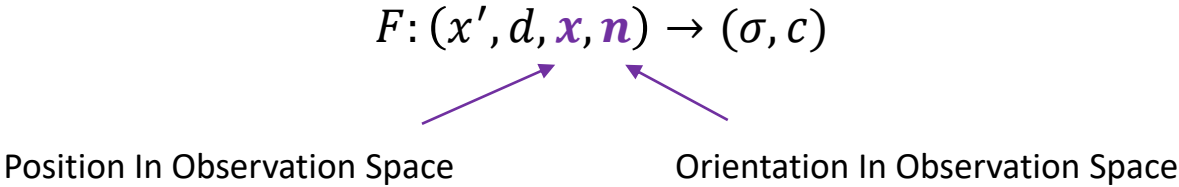

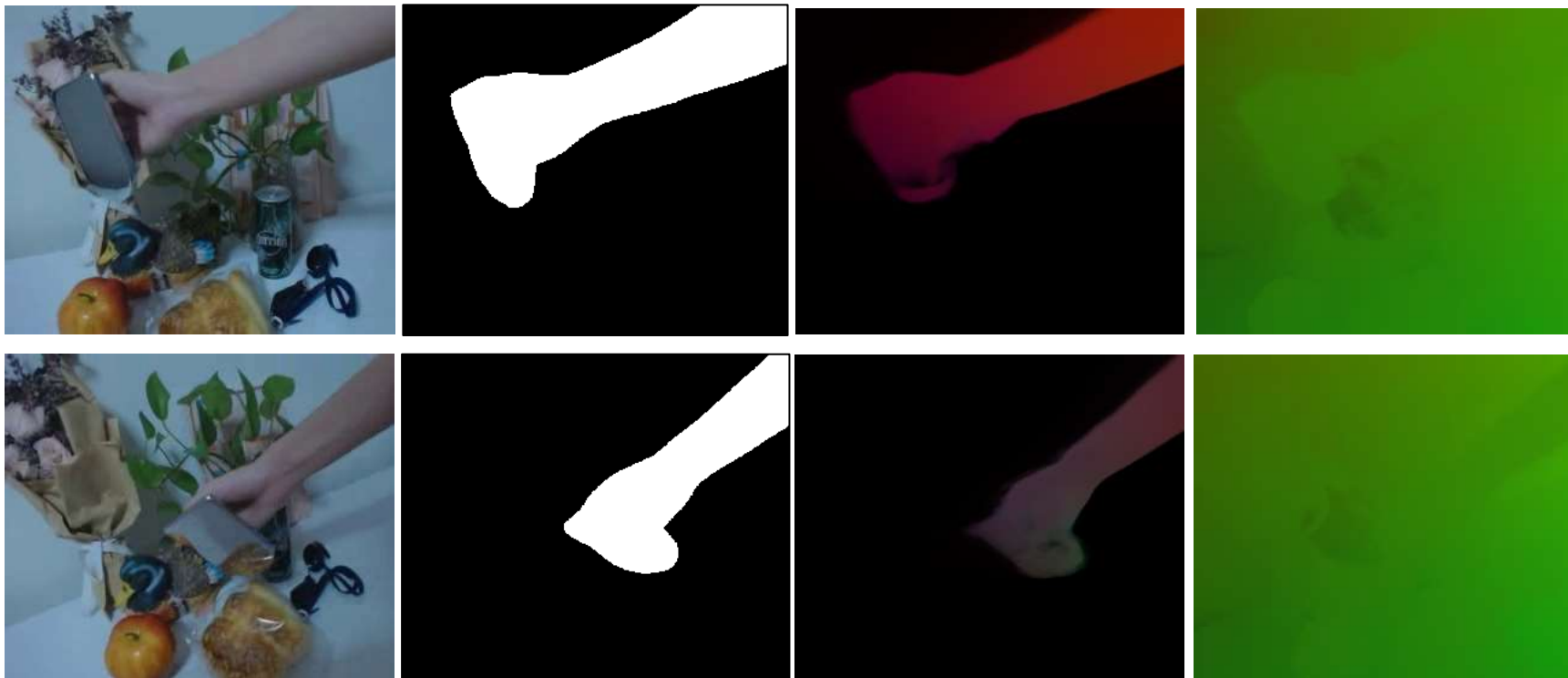

Test View RGB

Moving Object Mask

Deformation Field
NeRF-DS with Mask

Deformation Field
NeRF-DS w/o Mask

Introduce Moving Object Mask as an Invariance

Dynamic NeRF & Specular Objects

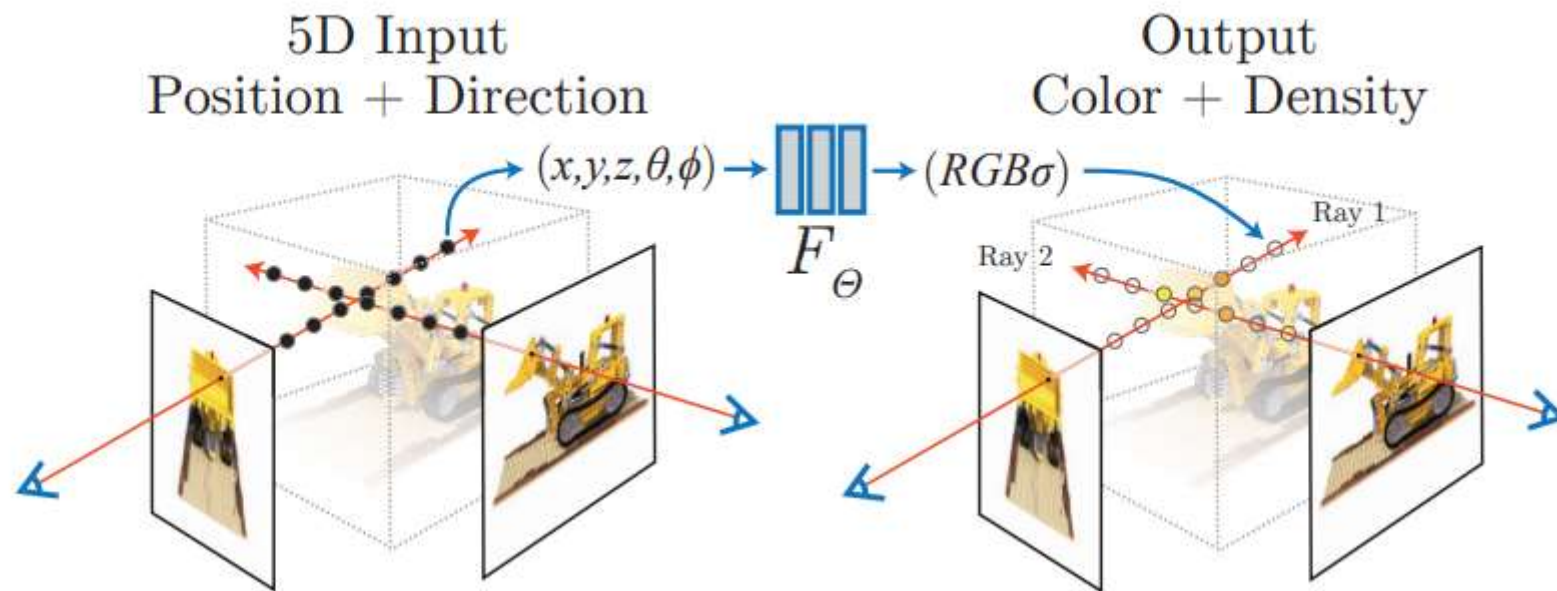

Neural Radiance Fields for Static Scenes

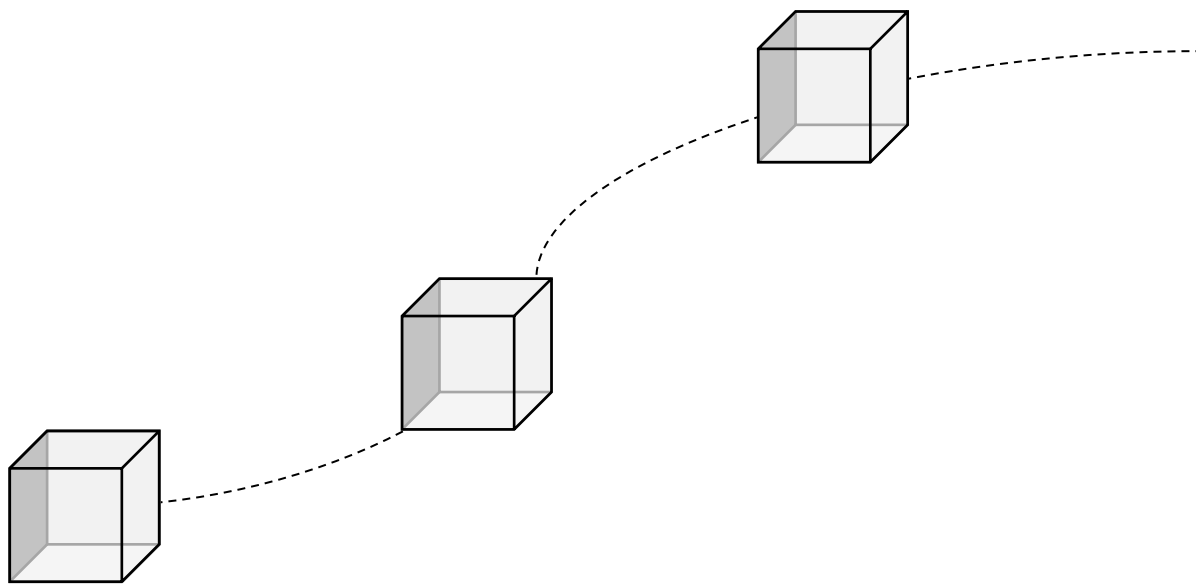

Neural Radiance Fields for Dynamic Scenes

Observation Space

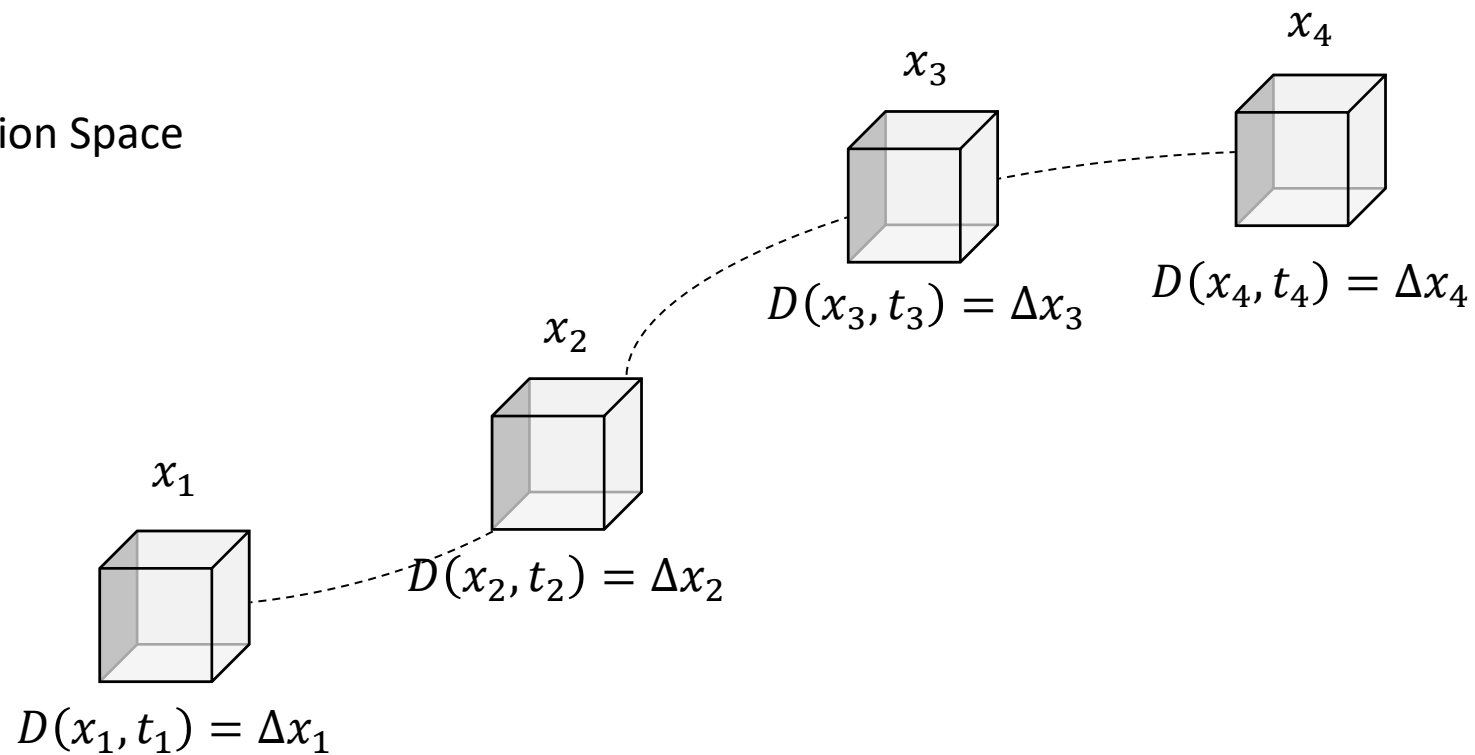

Neural Radiance Fields for Dynamic Scenes

Temporal Deformation Network

$$D(x, t) = \Delta x$$

Canonical Space

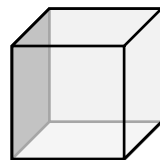

$$x' = x + \Delta x$$

Neural Radiance Fields for Dynamic Scenes

Temporal Deformation Network

$$D(x, t) = \Delta x$$

Static NeRF

$$f(x + \Delta x, d) = (\sigma, c)$$



Moving/Deforming Specular Object



Moving/Deforming Specular Object

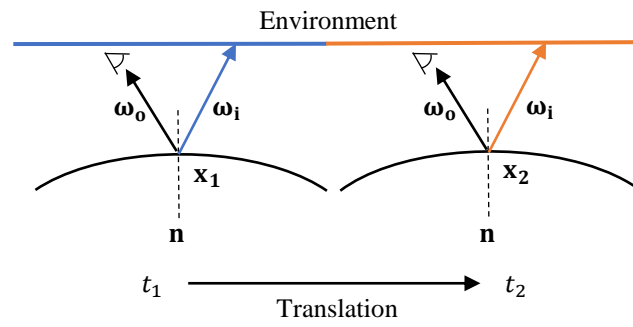

Moving/Deforming Specular Object

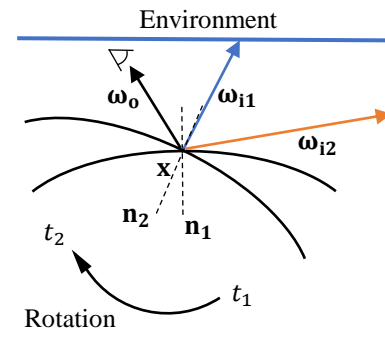

Moving/Deforming Specular Object

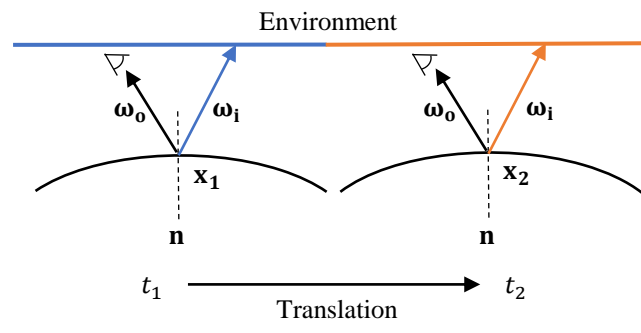

Position In Observation Space

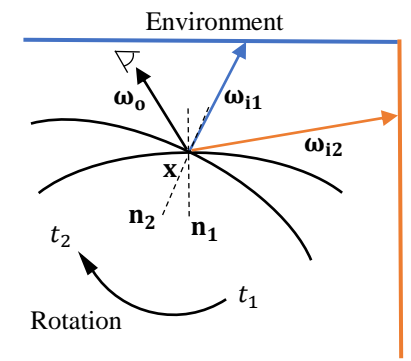

Orientation In Observation Space

Moving/Deforming Specular Object

Surface Aware Dynamic NeRF

Existing Dynamic NeRF

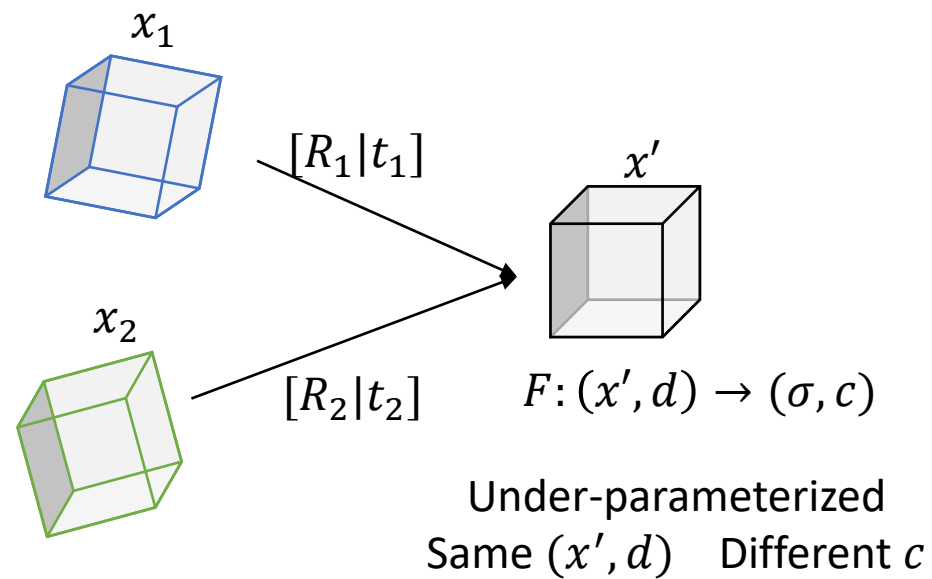
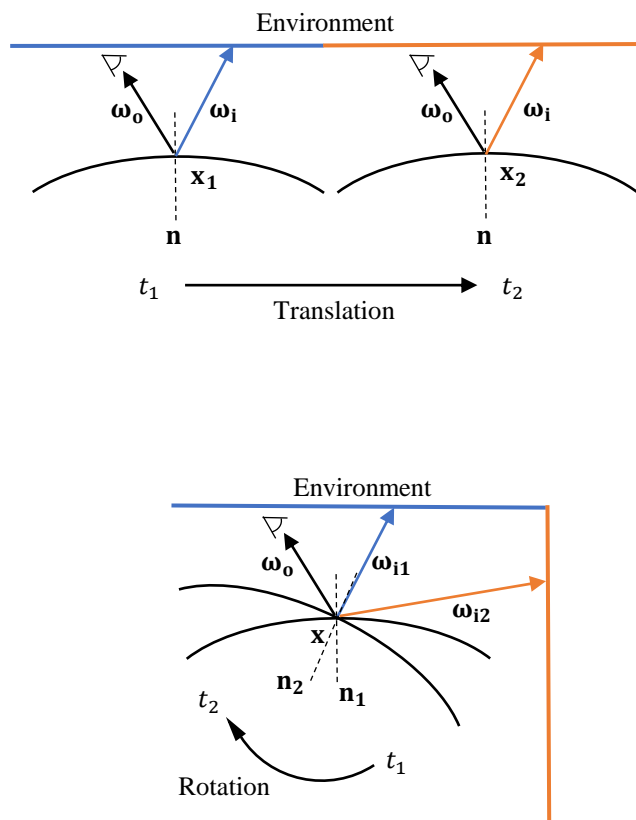

Surface Aware Dynamic NeRF

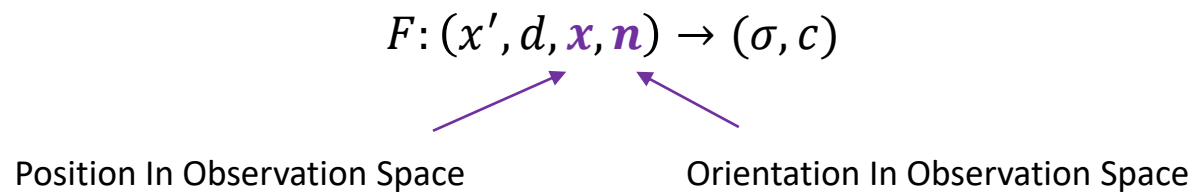

Negative Gradient of Density

$$\bar{n} = -\frac{\nabla_x \sigma(x)}{\|\nabla_x \sigma(x)\|}$$

Supervise Normal Output of MLP

$$n' = \operatorname{argmin}_{n'} \|n' - \bar{n}\|$$

Rotate Back to Observation Space

$$n = R^T n'$$

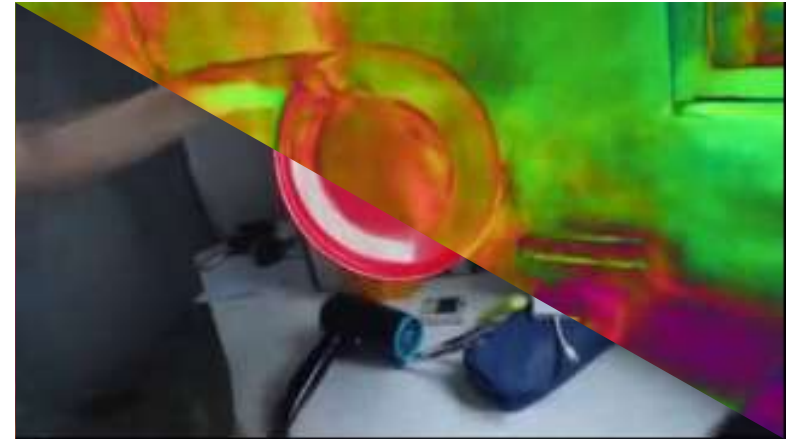

Surface Normal Estimation

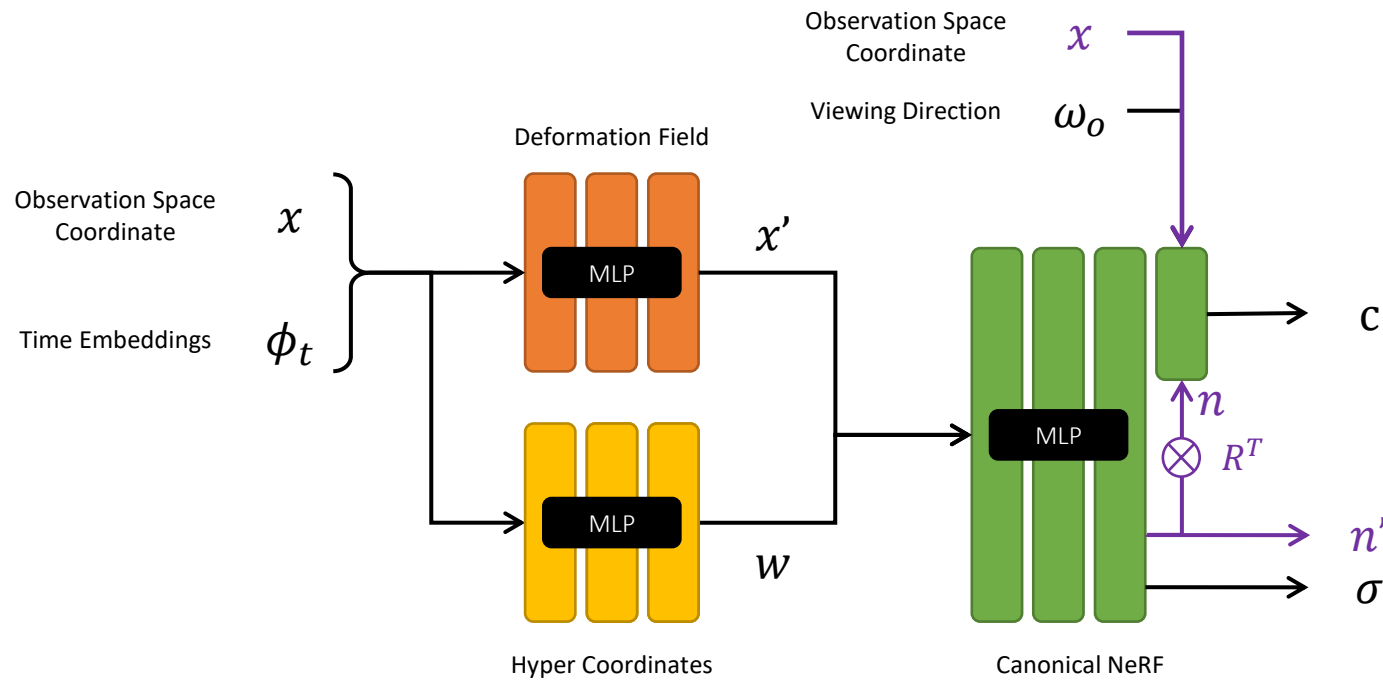

$$\bar{n} = -\frac{\nabla_x \sigma(x)}{\|\nabla_x \sigma(x)\|}$$

$$n' = \underset{n'}{\operatorname{argmin}} \|n' - \bar{n}\|$$

$$n = R^T n'$$

$$F: (x', d) \rightarrow (\sigma, c)$$

$$F: (x', d, x, n) \rightarrow (\sigma, c)$$

Mask Guided Deformation Field



Test View RGB



Deformation Field

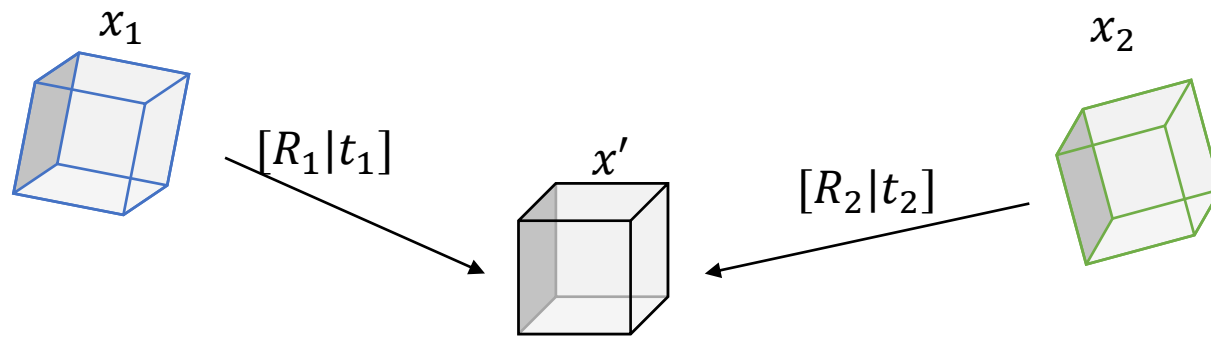

Deformation Encodes Temporal Correspondence

Deformation Supervised by Changing RGB Colors is not Reliable

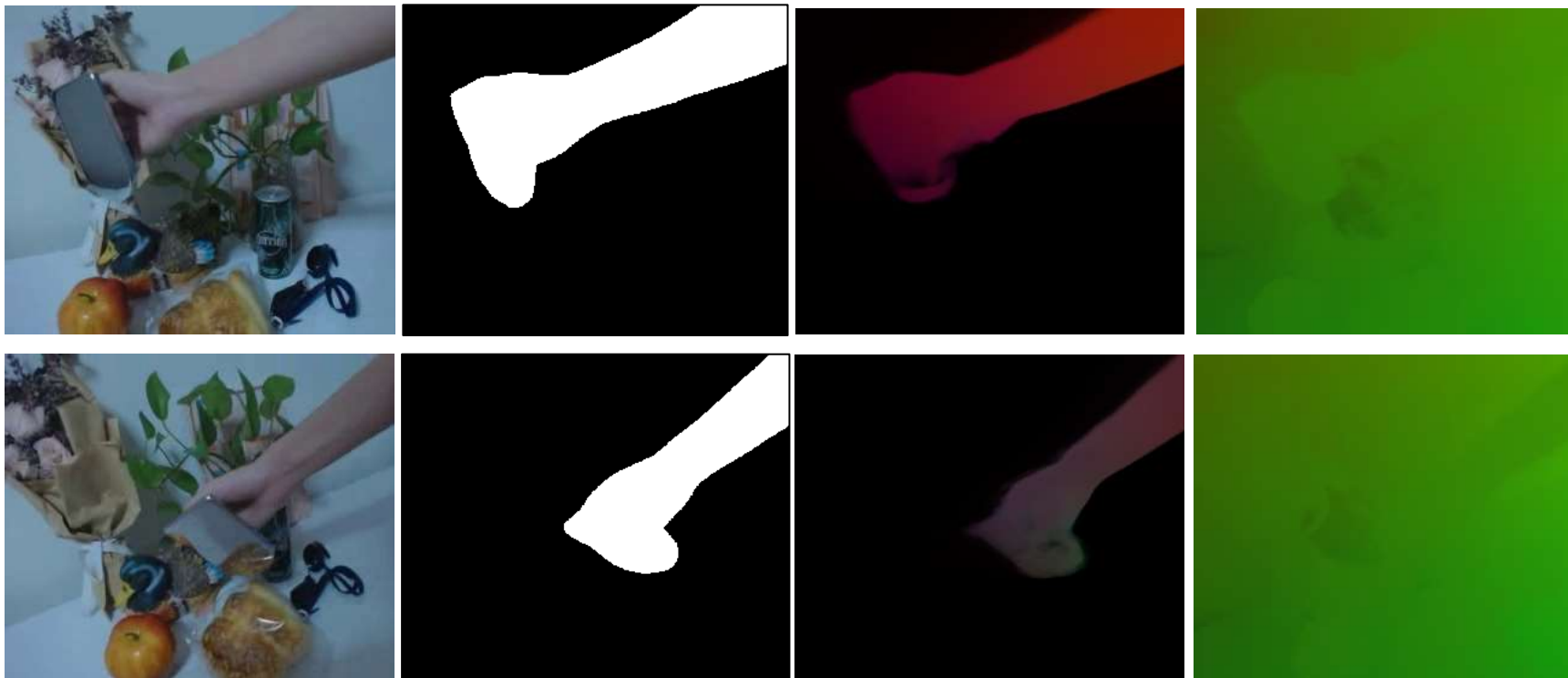

Test View RGB

Moving Object Mask

Deformation Field
NeRF-DS with Mask

Deformation Field
NeRF-DS w/o Mask

Introduce Moving Object Mask as an Invariance

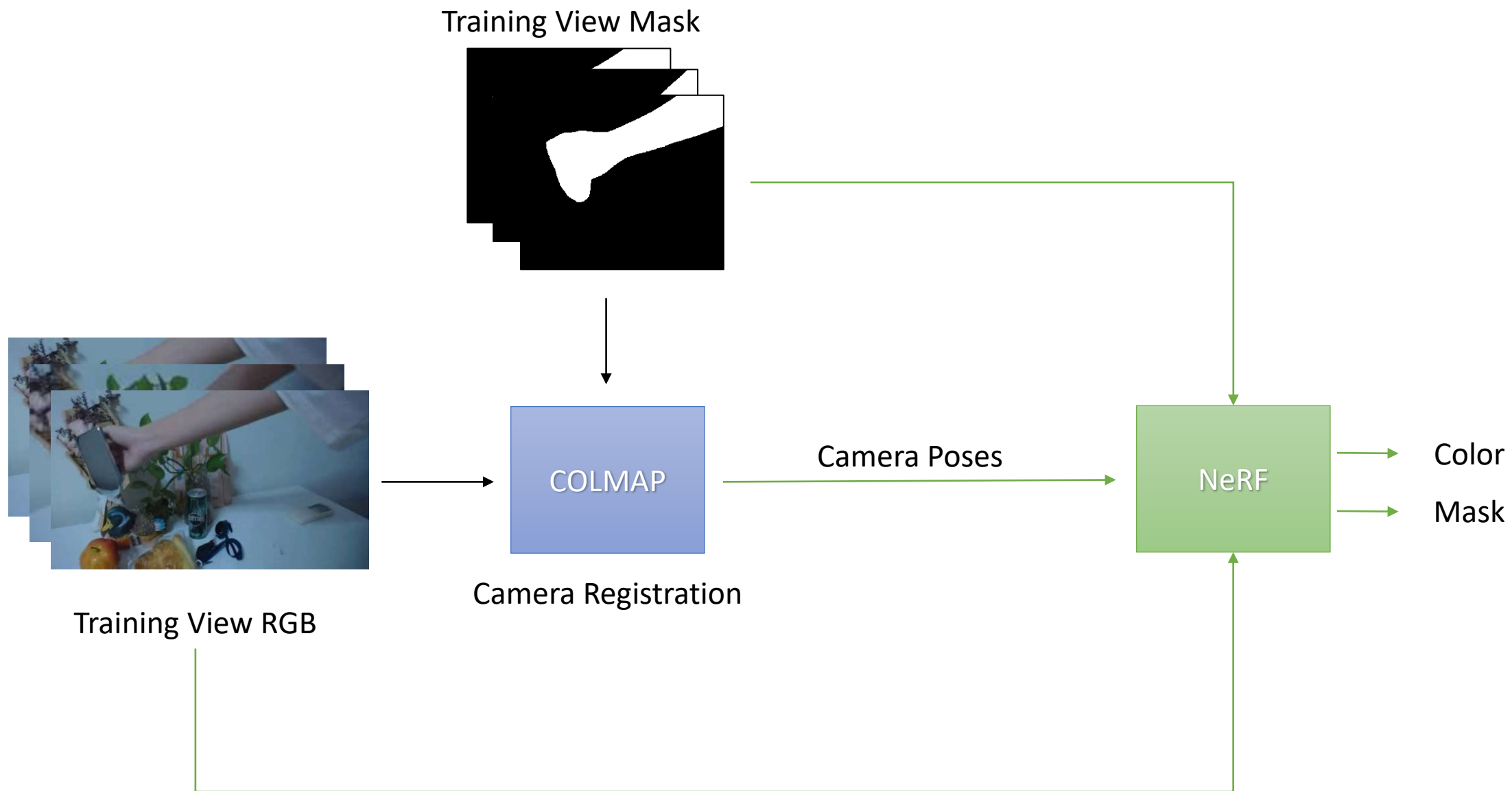

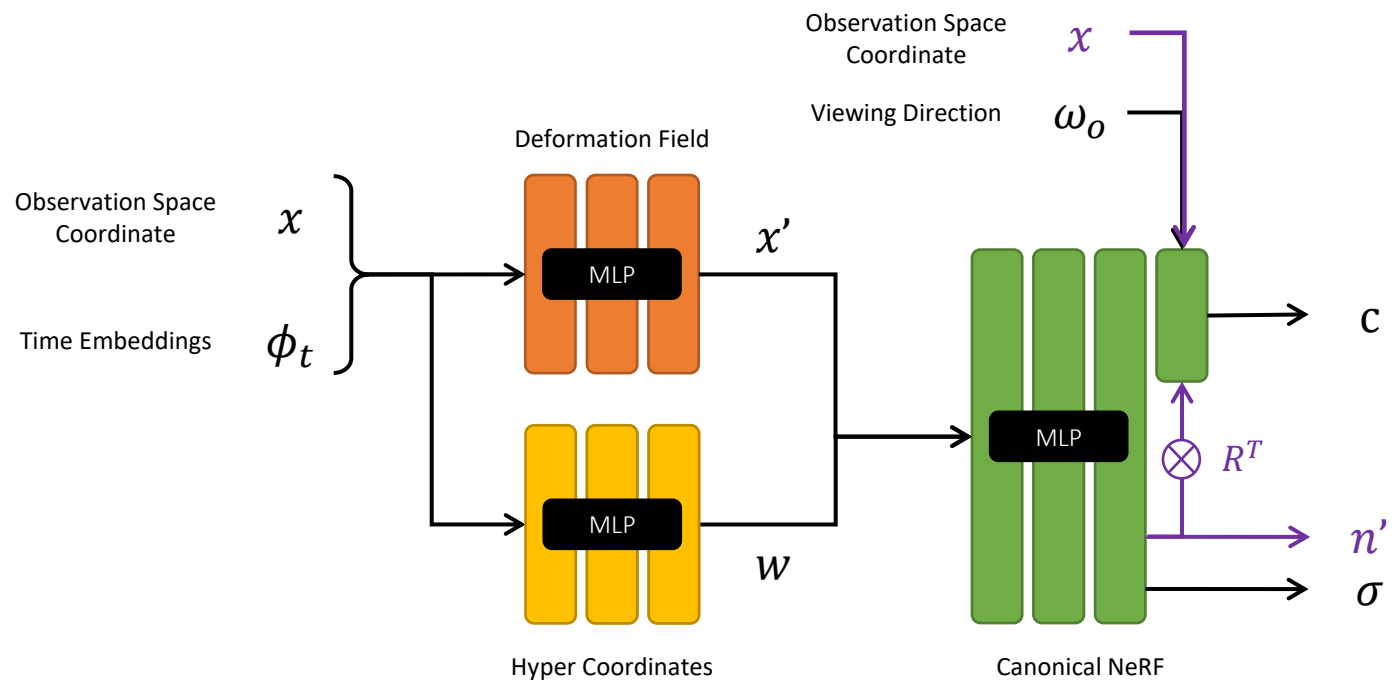

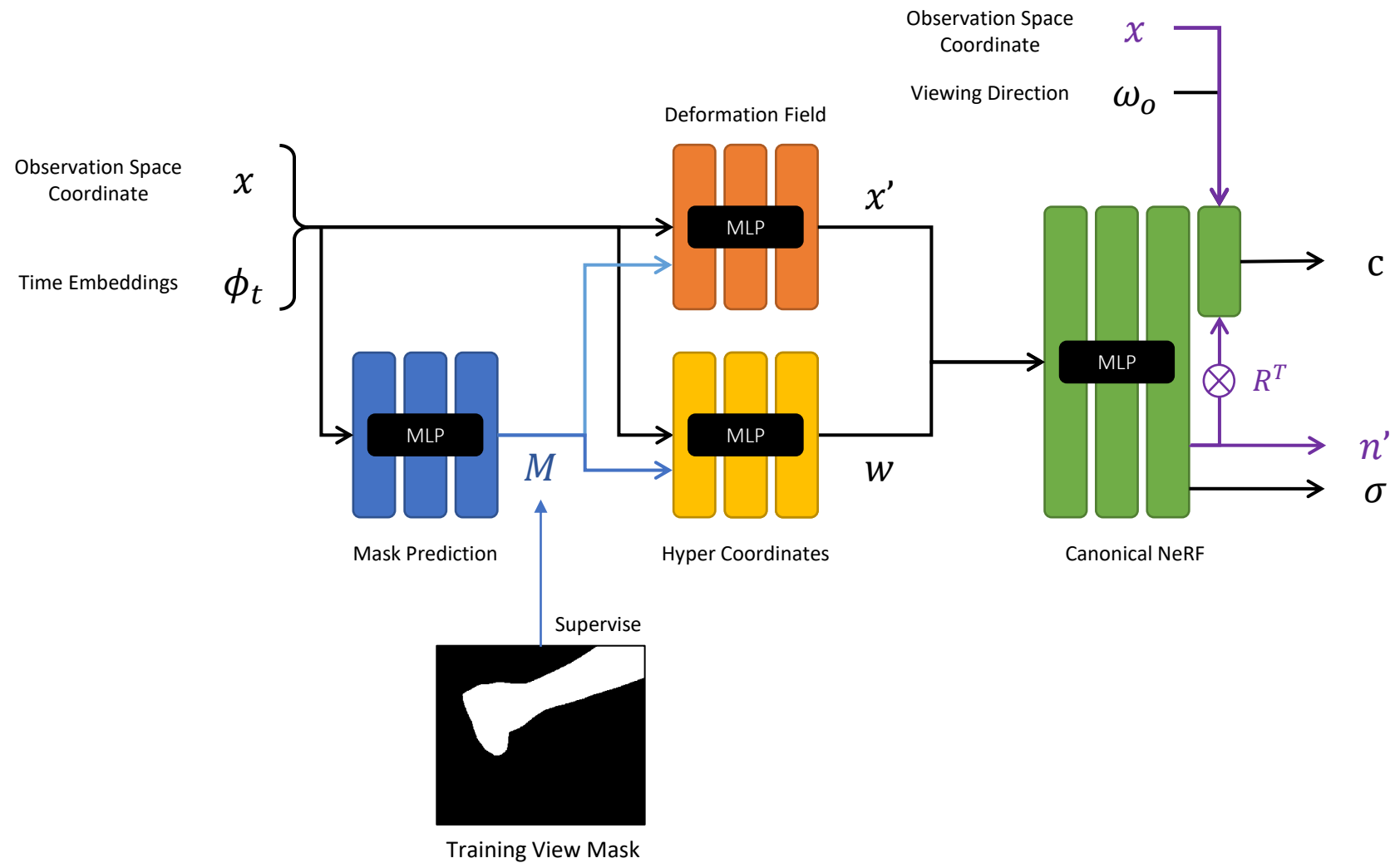

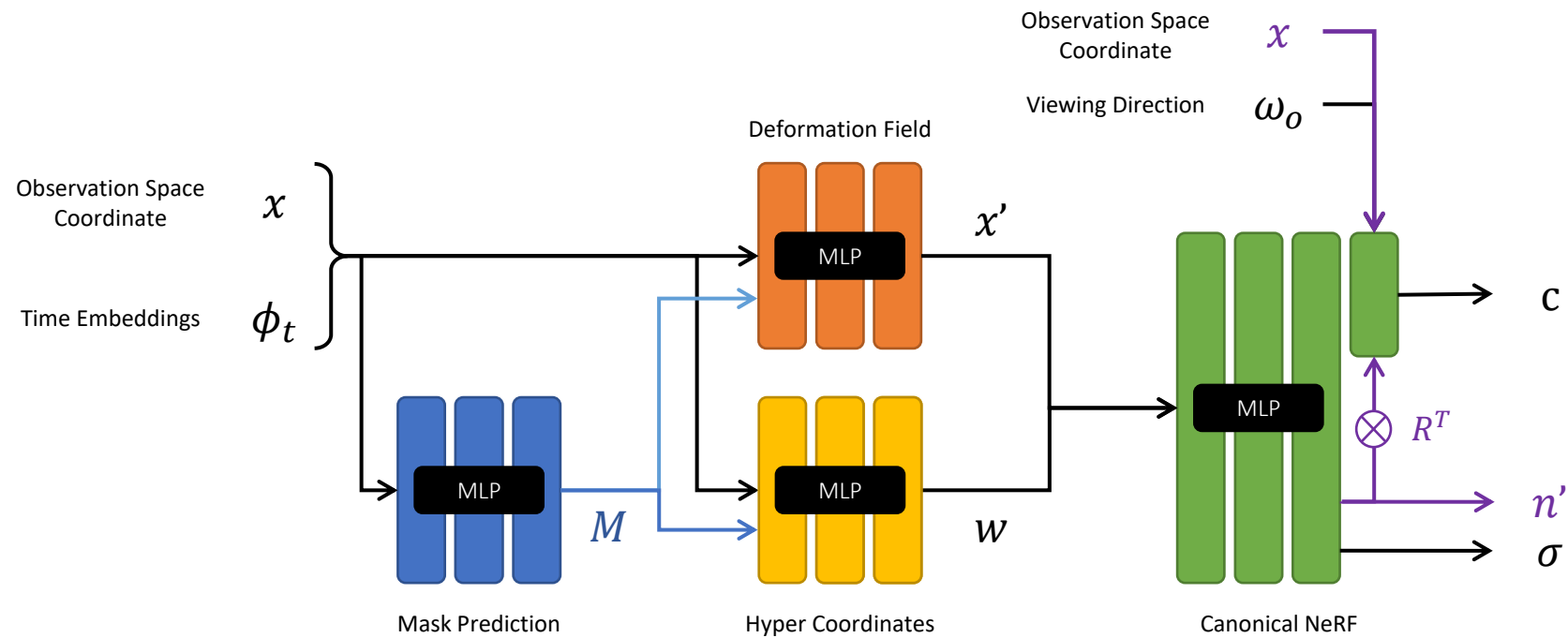

Predicted Color c



Predicted Mask M



Predicted Surface Normal n'

Qualitative Results



Novel View (GT)



NeRF-DS (Ours)



HyperNeRF



Nerfies



Ref-NeRF



Novel View (GT)



NeRF-DS (Ours)



HyperNeRF



Nerfies



Ref-NeRF



Novel View (GT)



NeRF-DS (Ours)



HyperNeRF



Nerfies



Ref-NeRF



Novel View (GT)



NeRF-DS (Ours)



HyperNeRF



Nerfies



Ref-NeRF

Thank You!

Project Page

